

LCD
Jameco Part #618003

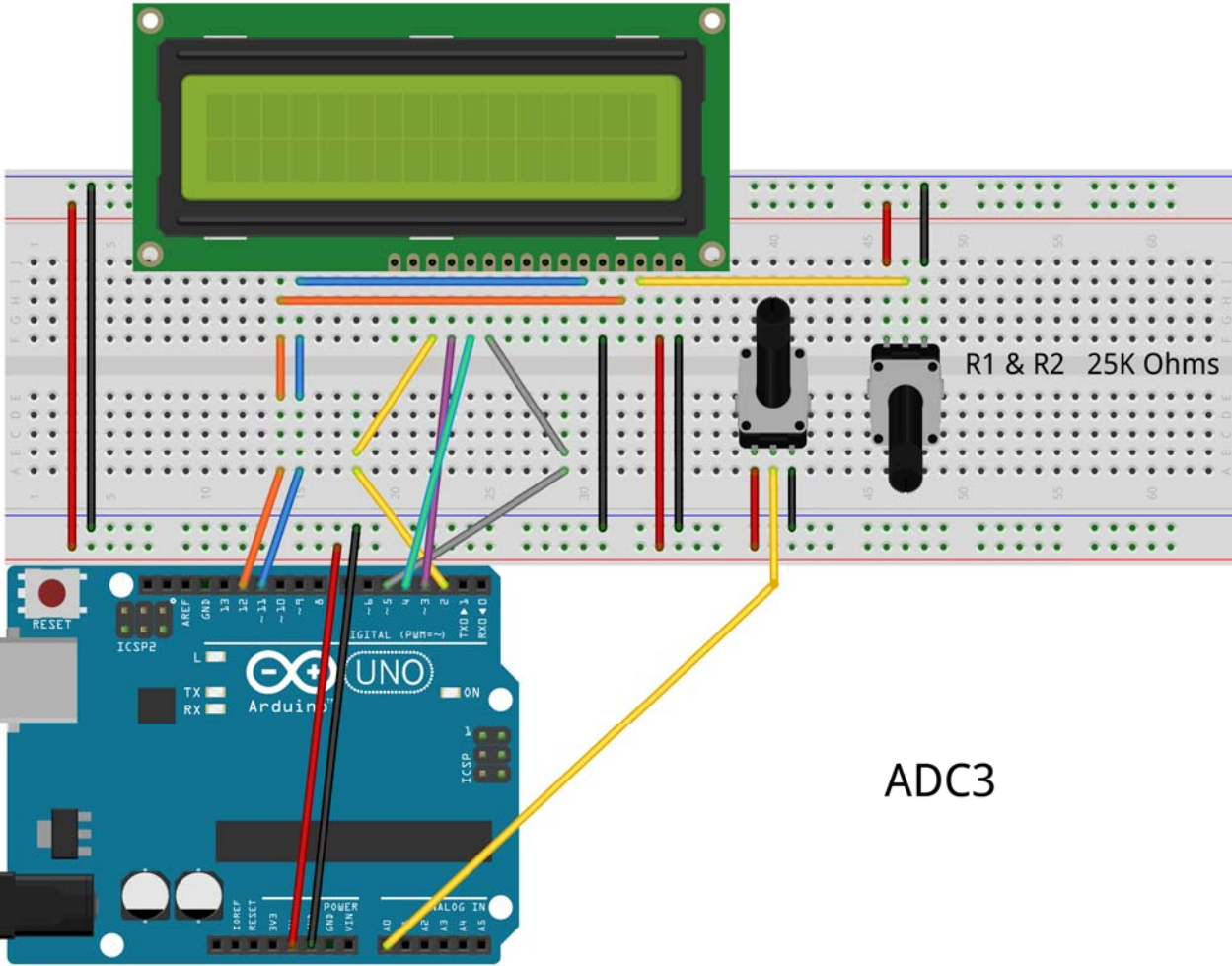

ADC3